

OP ERA_R

ROBOTIC
SANDING MACHINE



AUTOMATED MANUAL SKILLS



THE MARKET EXPECTS

a change in manufacturing processes enabling users to perform complex machining operations for small to medium-size production lots whilst achieving top performance with a modest investment.

BIESSE RESPONDS

with **technological solutions** which guarantee an excellent product quality with maximum machining flexibility. **Opera R** is the robotic sanding machine which is unique, offering levels of machinability, precision and quality never before achieved with the technology of this sector.



OPERA_R

- NO MACHINING LIMITS
- HIGH QUALITY, BLEMISH-FREE FINISHED PRODUCTS
- MACHINING PRECISION AND CONSISTENCY

MACHINING WITHOUT LIMITS

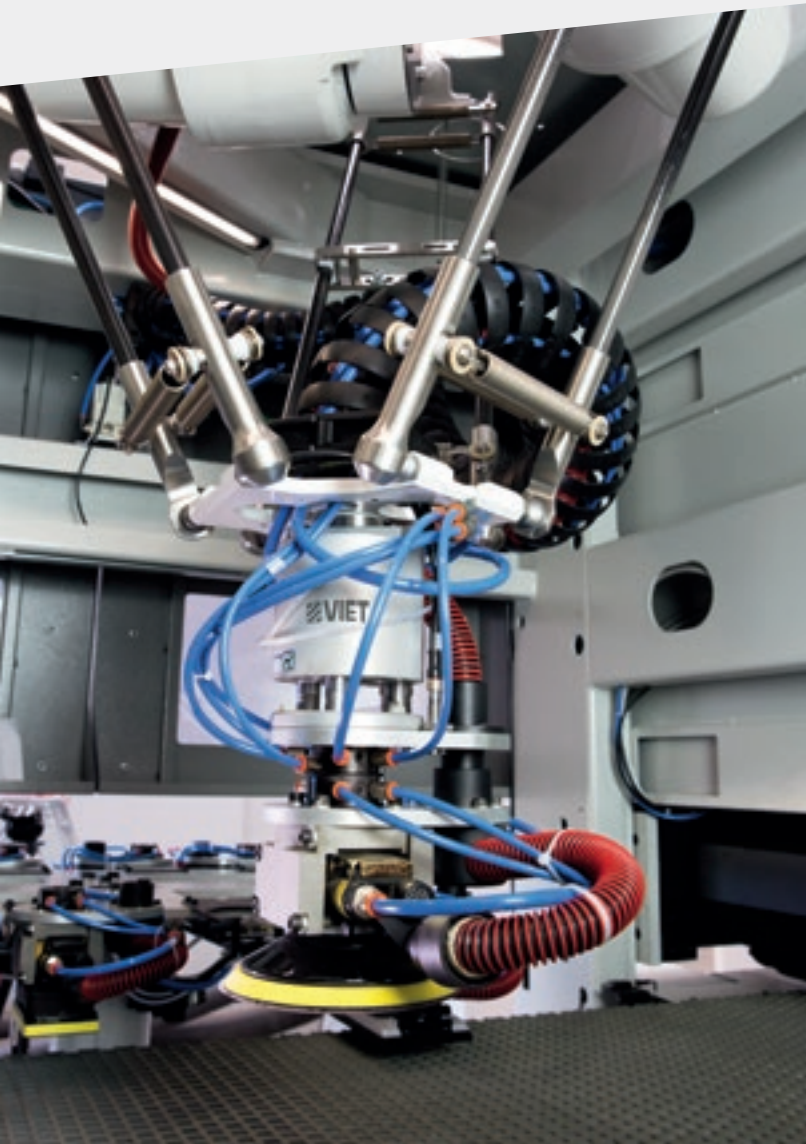

Biesse has always focused on technological development, offering the sensitivity and flexibility of skilled and complex machining operations with automated solutions, which eliminate the risk of human error, reduce production costs and increase efficiency.



The high precision robotic unit resolves problems relating to scratches, which may be made when machining the wood across the grain. It can also smooth multi-level surfaces as well as small internal corners.



Control Force is a patented system which is located inside the robotic unit and intelligently measures the amount of abrasive pressure applied to the panel, imitating the sensitivity of an artisan but with the accuracy and consistency of precision mechanics.

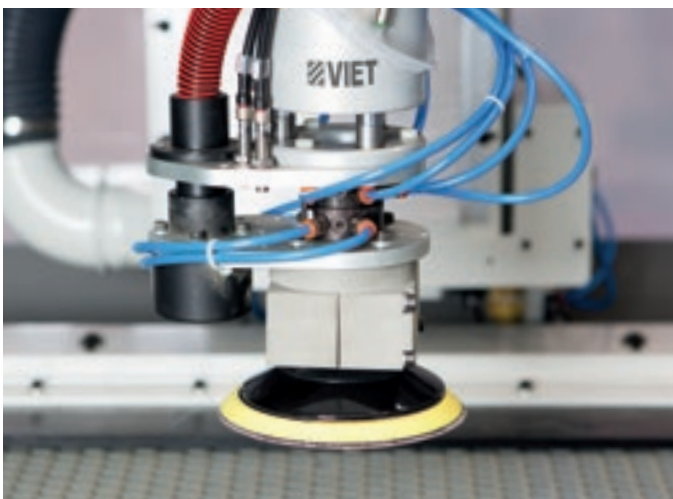

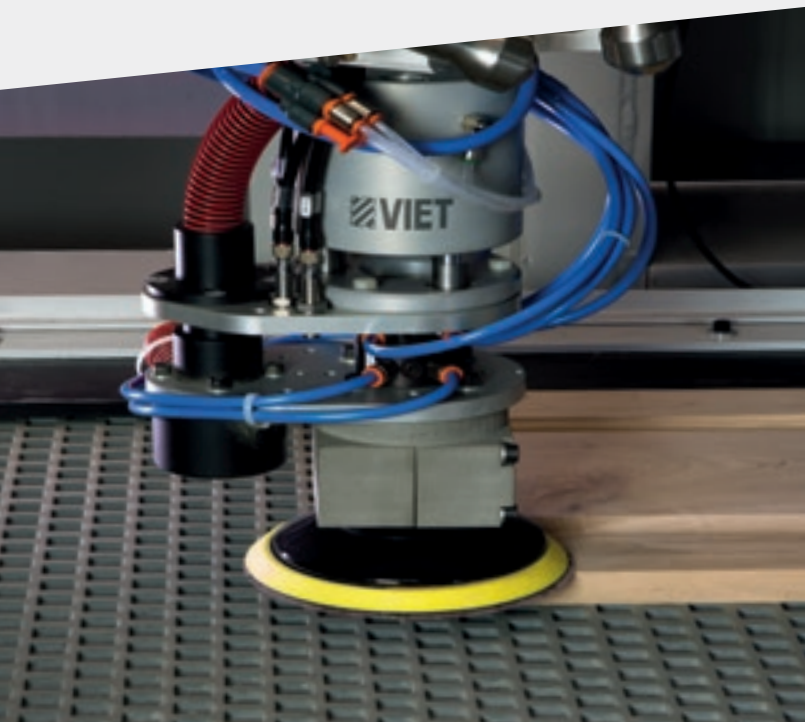

Freedom to machine the panel 'with the grain', in any orientation, increasing the number of contact points to produce ultra- high quality surface finishes.

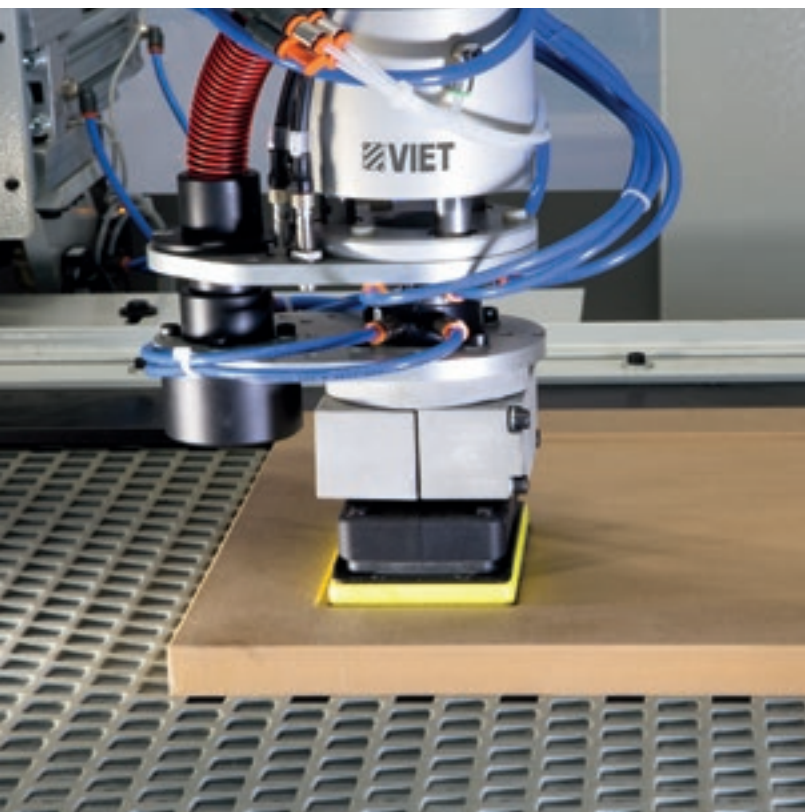

The new Opera R technology can machine elements with different levels like the inner side of profiles, 5 part doors, rebates and window frames, etc.

The Opera R can sand the component 'along the grain', regardless of orientation.

OPTIMUM CLEANING OF THE PANEL AND THE WORK ENVIRONMENT



The **Dust Free** system removes all dust during the machining operation itself. It's a device housed in the robotic unit and designed to improve the quality of the finish and the work environment.

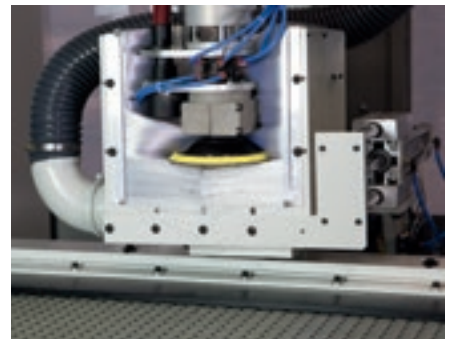
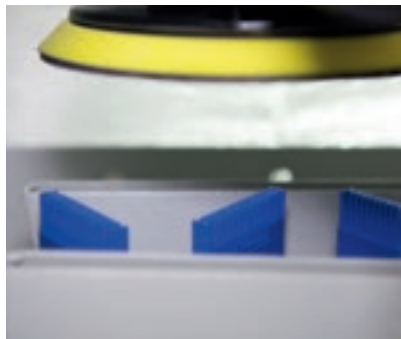
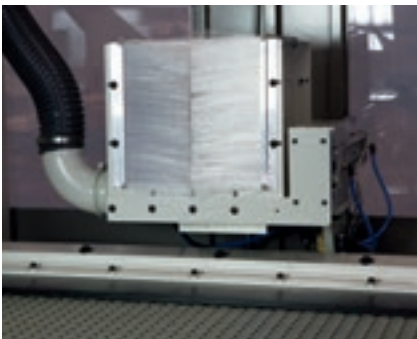

The **Cleaning Box** station, where the abrasive tool is cleaned and dressed, guarantees a longer working life for the tool without any need for manual intervention.

Multiple solutions which guarantee a better finish quality of the components and the machine.

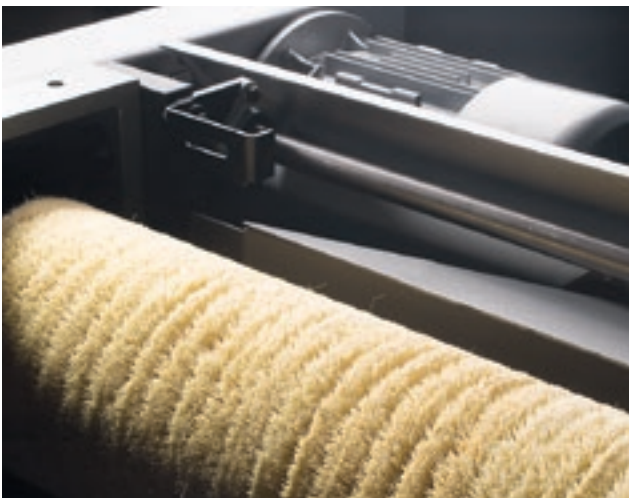

The panel cleaning brush can be fitted with bristles of different materials to deep clean the machined panels.

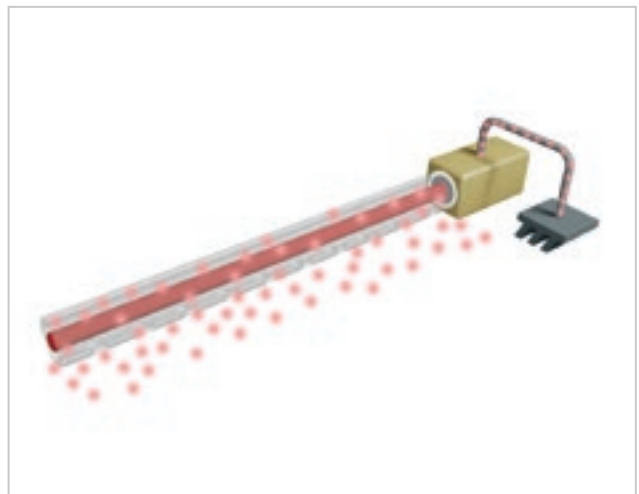

The anti-static bar eliminates electrostatic charges on painted panels.

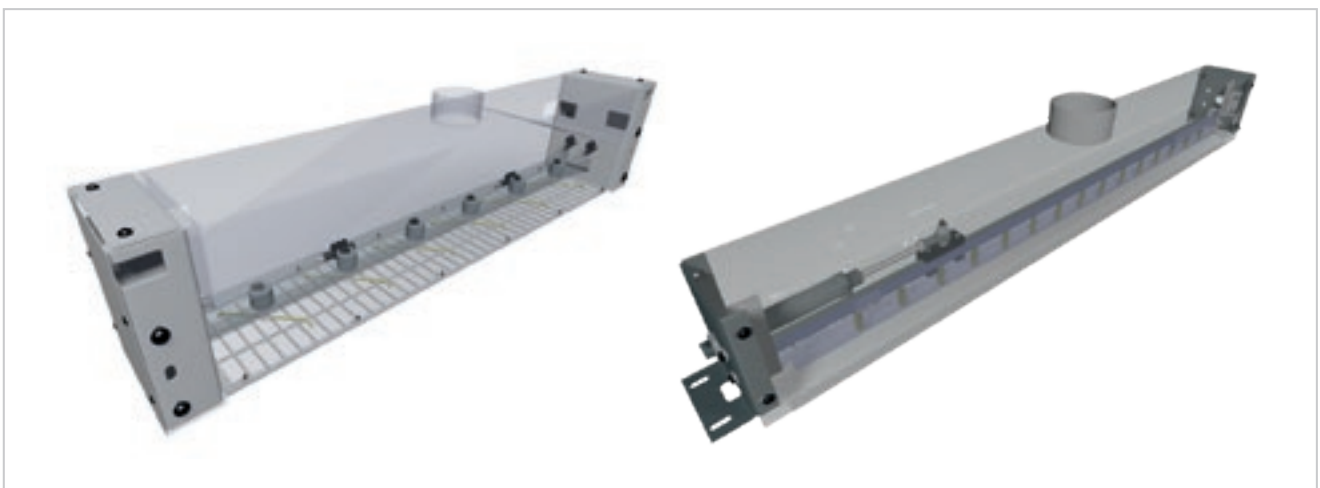

The **rotating blower**, positioned downstream of the machine, enables optimal cleaning of the panel's surface at the end of the sanding cycle.

The **linear blower** is used to finish cleaning the panel's edges. Ideally, it should be coupled with the rotating blower.

OPTIMISED CYCLE TIMES



Tool-holder station with 8 positions for a quick, automated tool change while the machine is running.

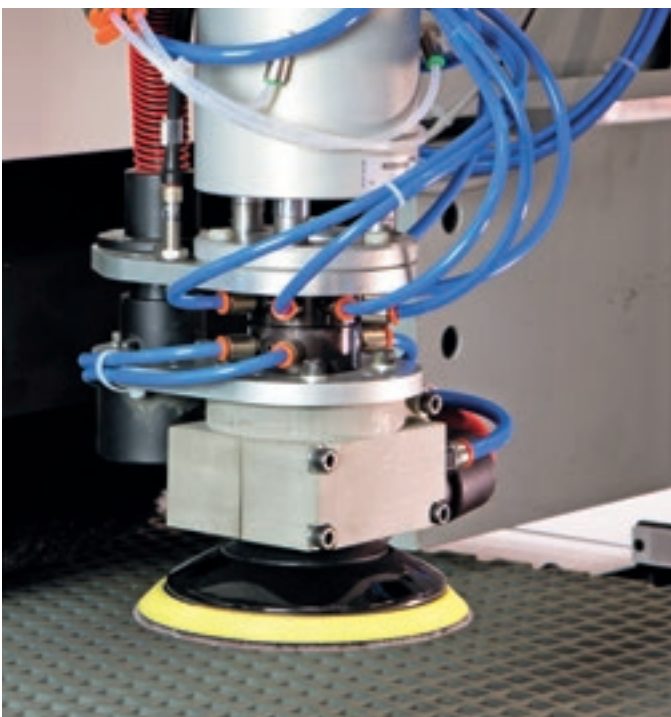

Electronic system for monitoring the correct positioning of the tool, to automate the process, removing the risk of human error.



PERFECT INTEGRATION IN THE PRODUCTION FLOW

Biesse can provide a range of bespoke solutions tailored to meet your specific productivity, automation and space requirements.



ENERGY SAVING SYSTEM

ECO-FRIENDLY SMOOTHING

With every attention to saving energy, the Biesse range of machines includes the E.S.S. system, which allows for energy savings of up to 30% with regard to both electricity consumption and CO₂ emissions. A perfect combination of Biesse technology and Italian genius.

The Energy Saving System is a series of devices designed by Biesse to minimise energy consumption during machining. They are engineered and designed to ensure a high degree of efficiency, as well as optimising production, with effective suction thanks to the automatic opening of the collectors, in accordance with the units in operation; in addition, an automatic system stops machines and places them on standby after a pre-determined period of inactivity, and the vacuum table system, which operates by means of an inverter, optimizes the vacuum for holding the panel, according to the size of the panel being processed.



TECHNOLOGY AT THE SERVICE OF THE USER



The base has a one-piece frame in welded steel. The generous thickness of materials used guarantees the stability and durability of the entire structure. Opera R is equipped as standard with a thick, wear-resistant fixed steel worktable which guarantees precision and sturdiness for any type of machining operation. The table is positioned 900mm from the ground, to facilitate panel loading and unloading.

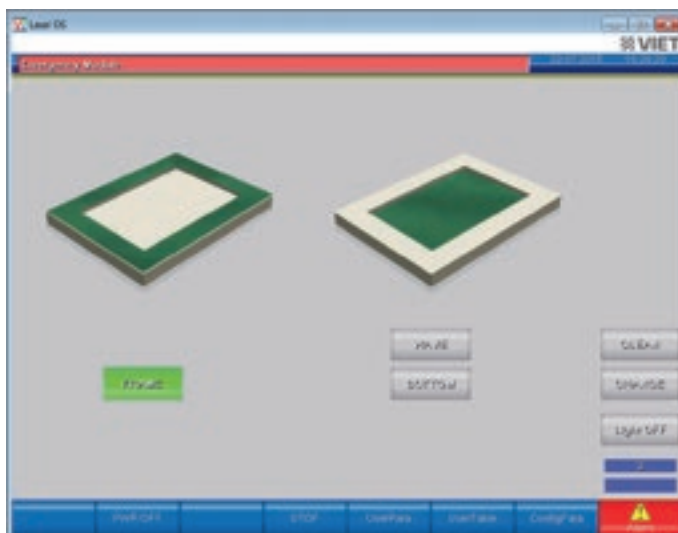

Opera R is managed via an IPC electronic control with a 15" touchscreen. The control manages all the machine parameters and the lists of tools and types of panel to be machined. Thanks to its hardware, it is able to perform complex machining cycles quickly and reliably.

TECHNICAL SPECIFICATIONS

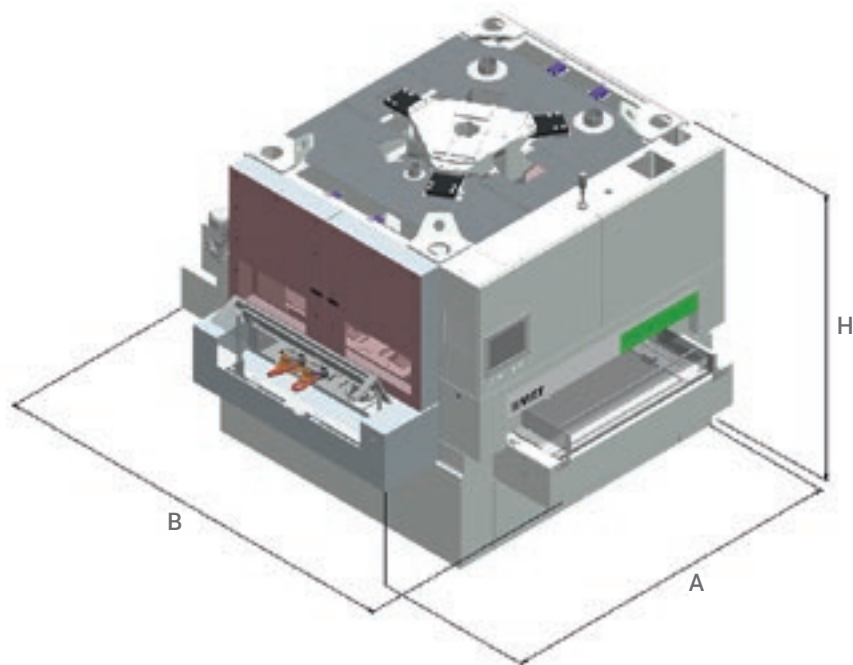

	OPERA R
A	2535 mm
B	3105 mm
H	2300 mm
Maximum operating width	760 mm
Max. machinable thickness	60 mm
Advance speed	2 - 10 m/min
Operating pressure	6 bar
Weight	3650 Kg
Robot loading capacity	12 Kg

The technical specifications and drawings are non-binding. Some photos may show machines equipped with optional features. Biesse Spa reserves the right to carry out modifications without prior notice.

Weighted sound pressure levels at the machine entry operator station: 75.0 dB(A) without load, 76.0 dB(A) with load. Weighted sound pressure levels at the machine exit operator station: 70.5 dB(A) without load, 71.0 dB(A) with load.

Viet Srl. designed the machine to reduce airborne noise emission at source to the lowest possible level, in accordance with the requirements of Community Directive 2006/42/EC, and commissioned a test to determine the sound pressure emission level at the operator station for the smoothing/sanding machine. Standards: The measurement was carried out in compliance with UNI EN ISO 19085-8:2018, UNI EN ISO 11202:2010. The noise levels shown are emission levels and do not necessarily correspond to safe operation levels. Even though there is a relation between emission levels and exposure levels, this cannot be used reliably to establish whether further precautions are necessary. The factors determining the noise levels to which the operative personnel are exposed include the length of exposure, the characteristics of the work area, as well as other sources of dust and noise, etc. (i.e. the number of machines and processes concurrently operating in the vicinity). In any case, the information supplied will help the user of the machine to better assess the danger and risks involved.

VIETWATCH

Troubleshooting
at your fingertips.

Viet has anticipated market trends, transforming an everyday object into a work tool and creating a piece of digital technology that can provide its customers with innovative machine management solutions

The VIETWATCH wireless control system provides the operator with real-time updates on the status of the machine.

It can:

- Send notifications and indications to the operator regarding production status, the types of processes being carried out and the machines in operation at a given time.
- Constantly provide the operator with information on any machine stops or alarms, as well as providing a notification when the abrasive paper needs to be replaced.

The operator can then act on these notifications, either via voice commands or by simply touching the screen of the watch.



+ PRODUCTIVITY
+ EFFICIENCY
- MACHINE DOWNTIME

VIET REDEFINES WHAT YOU EXPECT FROM A WATCH

Viet Watch has been designed to simplify and rationalise work management.

Greater safety, ease of use and ergonomics are within everyone's reach.

WITH THE NEW VIET DEVICE, MONITORING THE STATUS OF YOUR MACHINE REMOTELY IS SIMPLE, SO YOU CAN ENSURE EVERYTHING IS UNDER CONTROL AT ALL TIMES.

Key features



DASHBOARD
Real-time information on the status of the machine.



COMMANDS
Menu of the basic commands.



NOTIFICATIONS
List of alarms or maintenance requests. Every time the machine signals that there is a problem, or when there is a maintenance request, the Viet Watch vibrates and a danger icon is displayed on the screen.

Founded in Italy,
international native.

We simplify your
manufacturing
to make the process
of any material



ur
g process
potential
I shine.

We are an international company that manufactures integrated lines and machines to process wood, glass, stone, plastic and composite materials and what will come next.

Thanks to our rooted competence nurtured by an ever-growing worldwide network, we support your business evolution – empowering your imagination.

Master of materials, since 1969.

Join the
Biesse world.

[biesse.com](https://www.biesse.com)



MADE WITH BIESSE

A SINGLE SOLUTION FOR SMOOTHING AND PROFILING

Alpilegno, a Leader in the sector of high-quality, high-performance windows and doors, performs sanding operations followed by profiling operations in its Val di Ledro (TN) manufacturing unit. Loris Cellana, an entrepreneur with long-standing experience in this sector, recalls how he evaluated machinery and system suppliers for over two years to find one that could guarantee a cutting-edge finished product: "In the end I chose Biesse". The core of the new manufacturing line is a Uniwin machine, combined with a modern 5-axis Rover C that produces doors. "I think that Uniwin is already a good profiling machine in itself, but what was equally important to me was its interaction with other line components, such as the planer, the sanding machine and the press, and the material flow between the

various machines". Components are custom-cut and stored in a loading device by Biesse's automation programme that feeds the automatic planer. A conveyor belt moves the work pieces from the planer directly to the sanding machine (a Viet Narrow 334 Bottom, also supplied by Biesse). From there, the components are sent to the Uniwin's loader, from which they are picked to be fully processed. 72, 80, 92 and 104 mm thicknesses in wood and wood-aluminium are processed. The magazines house up to 98 tools that are always available. Such tools can be changed in real time during machine operation thanks to a chain-operated tool-changer.

"Assembly precision enables us to avoid having to remove glue residues from the frame", explains Cellana: "in this way, sur-

face calibration and sanding must be arranged the one after the other, to go to the pressing stage immediately after profiling". Moreover, individual components are not painted before they are pressed, as it is customary. As a matter of fact, Cellana paints the entire frame. The compact production line occupies a footprint of only 15x15 metres; components are always handled forward and backward from the planing to the profiling machine, leaving enough space also for a walkway. "I like Biesse's solution: it is compact, the machines are efficient and, since they all come from the same supplier, it is easy to learn how to operate them", explains a visibly satisfied Cellana.

Source: Holzkurier Austrian magazine/special Nuremberg Exhibition issue.



SOPHIA

GREATER VALUE FROM MACHINES

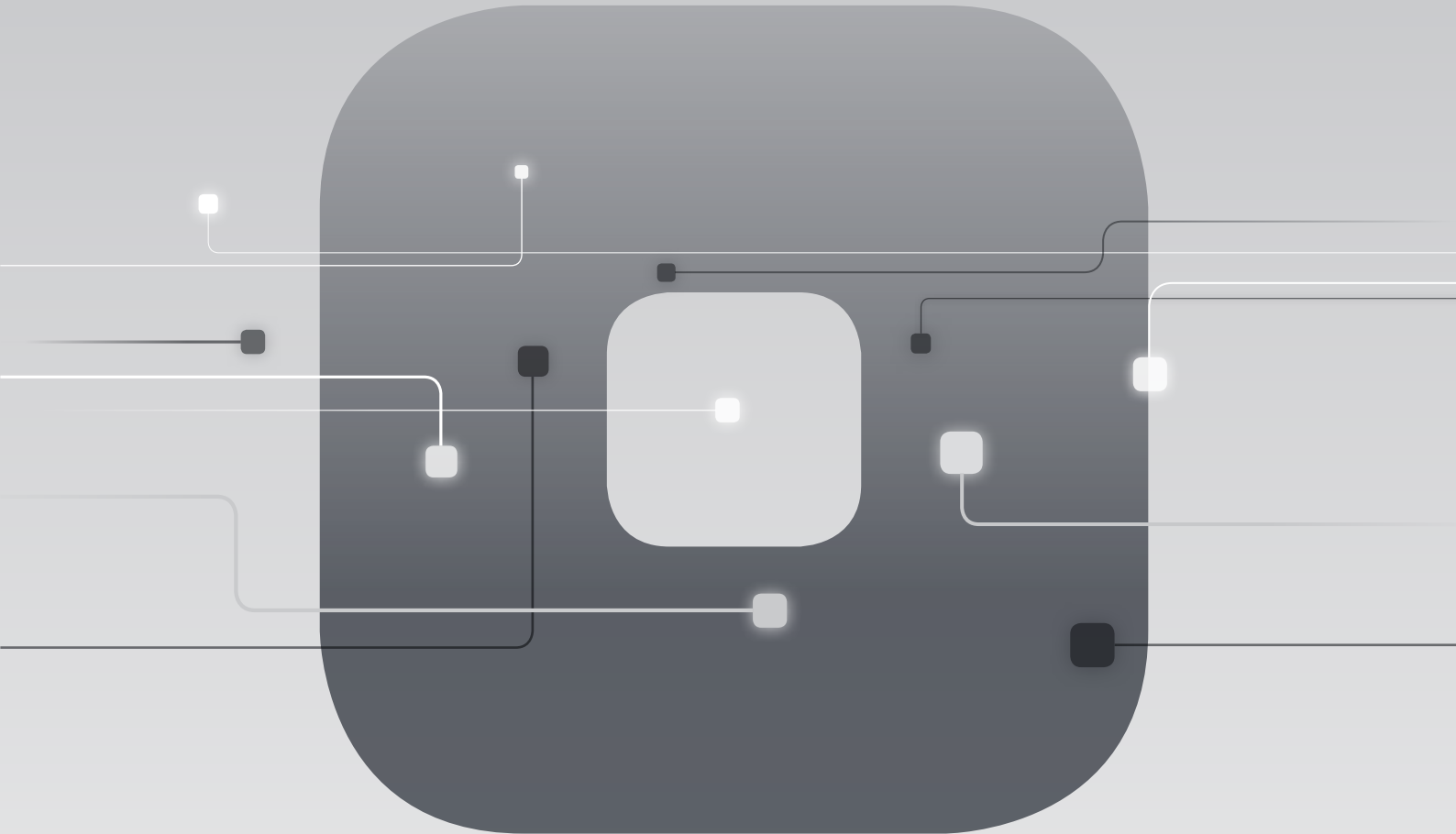

The Biesse IoT platform which enables customers to access an extensive range of services to streamline and rationalise their work management processes.

SERVICES

PROACTIVITY

ANALYSIS

